



TOILET
PARTITIONS.COM
presents

ClassicSeries®

High Pressure Laminate Partitions and Screens

Manufactured by Bobrick Washroom Equipment Inc.

1542 SERIES

Specify Product Application:

- Toilet Partitions
- With Outswing Door
- Urinal Screens

Specify Series Required:

- 1542 Series Overhead-Braced

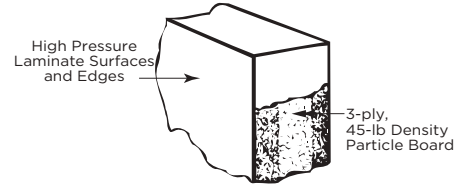

STANDARD-SIZE COMPONENTS:

Stiles: For compartments - 3", 4", 5", 6", 7", 8", 10", 12", 16", 18", 20", or 24" (8, 10, 13, 15, 18, 20, 25, 30, 41, 46, 51, or 61cm) wide; for screens - 6" (15cm) wide. *Floor-anchored* - 69" (175cm) high; *overhead braced* - 82-5/16" (209cm) high; *ceiling-hung* - 83" (211cm) high for 8' (244cm) ceilings or as required up to 10' (305cm) ceilings.

Doors: 58" (147cm) high. *Inswing doors* are standard for 22" to 37" (56-94cm) widths in whole-inch increments. *Outswing*^b doors are standard for 25" to 37" (64-94cm) widths in whole-inch increments.

Panels: For Compartments - Up to 84" (213cm) wide; 58" (147cm) high. For wall-hung screens - 42" or 48" (107 or 122cm) high; 18" or 24" wide (46 or 61cm). For ceiling-hung and floor-anchored screens - 58" (147cm) high; 24", 36", 48", or 60" (61, 91, 122, or 152cm) wide.

^a Minimum 8" (20cm) wide stile recommended for ceiling-hung and flooranchored compartments.

^b Use outswing doors to comply with local codes requiring access for physically disabled persons.

COMPARTMENT AND SCREEN ELEVATIONS

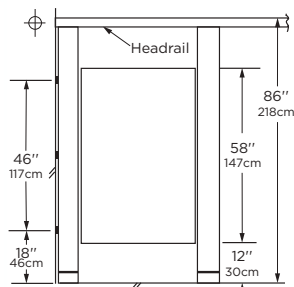

1542 Series Overhead-Braced

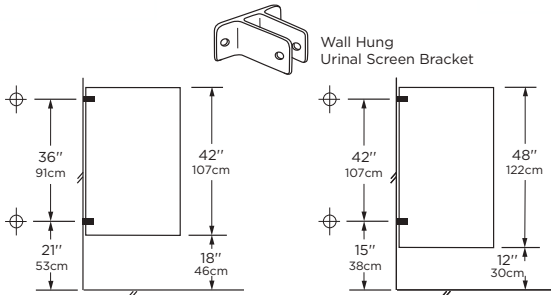

1545 Series Wall-Hung 42" or 48" Urinal Screen

⊕ These mounting points require wall backing. For suggested backing methods, Bobrick Advisory Bulletins TB-32 for ceiling-hung installations and TB-46 for floor-anchored are available upon request.

TYPICAL HARDWARE DETAILS

Standard gaps are provided at all walls and between components to allow for hardware attachment.

Wall gaps are standard 1/2" to 1"

Through-Bolted, Bright-Polished, Chrome-Plated Zamak (standard on all compartments)

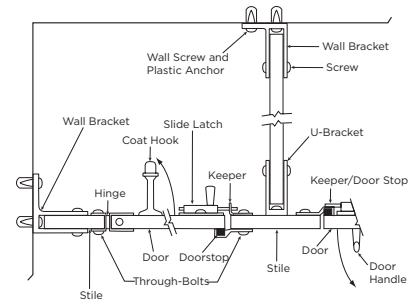

TYPICAL INSTALLATION DETAILS

Overhead-Braced Floor Leveling Device

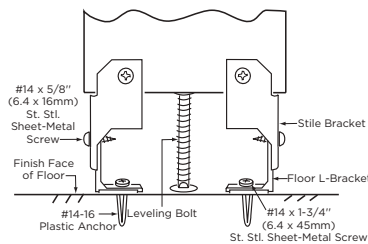
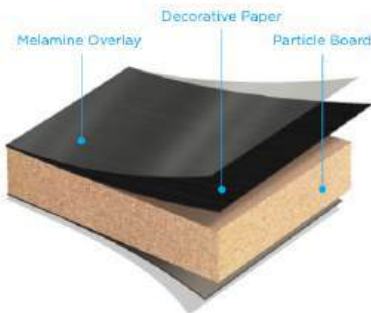

Overhead-Bracing

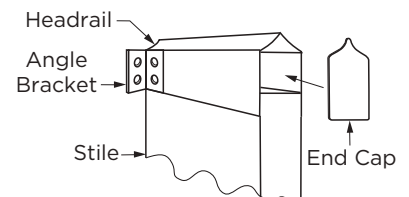

MATERIALS:

Stiles — 1" (25mm) finished thickness: 3-ply, 45-lb (20.4-kg) density, resin-impregnated particle board; surfaces and edges are .050" (1.3mm) thick, high-pressure plastic laminate with colored face sheets and matte finish.

Leveling Device — Overhead-Braced Series: 12-gauge (2.8mm), 3" x 1-1/4" (75 x 32mm) plated steel stile bracket factory installed to bottom of stile. Furnished with leveling bolt, shoe retainer, floor L-bracket, plastic anchor #14-16, #14 x 5/8" (M6.3 x 16mm) stainless steel sheet-metal screws and #14 x 1-3/4" (M6.3 x 45mm) stainless steel sheet-metal floor screws.

Leveling Device — Floor-Anchored or Ceiling-Hung: 3/8" x 1" (10 x 25mm) steel bar, zinc-chromate plated, bolted to stile using 6" x 3/8" (152 x 10mm) diameter carbon steel lag bolt. Furnished with 3/8" (10mm) diameter threaded rods, hex nuts, washers, spacer sleeve (ceiling-hung only), expansion shield and shoe retainer.

Shoe: — 18-8, Type-304, 22-gauge (0.8mm) stainless steel with satin finish; 4" (102mm) high. Patented one-piece shoe is open-ended, and may be mounted blind against wall using shoe clip fastener on wall side.

Panels and Doors — 1" (25mm) finished thickness: 3-ply, 45-lb (20.4-kg) density, resin-impregnated particle board; surfaces and edges are .050" (1.3mm) thick, high-pressure plastic laminate with colored face sheets and matte finish.

Headrail: (1542 Series Only): Extruded anodized aluminum. Enclosed construction with vandal-resistant sloping top.

Wallpost: 1-1/2" (38mm) x 1" (25mm) x 58" (147cm), 16 gauge (1.6mm) thick, 18-8, Type-304 stainless steel. Pre-drilled for door mounting hardware.

Door and Mounting Hardware — Hinges, door latches, door keepers, coat hooks, and mounting brackets are constructed of chrome-plated zamak. Toilet compartment door is locked from inside by sliding door latch into keeper. A locked compartment may be opened from outside by lifting door to disengage latch from keeper. Doorstop prevents inswing door from swinging out beyond stile; on outswing door, the doorstop/keeper prevents it from swinging in beyond stile. Combination coat hook and bumper reduces damage from door inside compartment.

INSTALLATION:

Bobrick installation instructions are packed with each shipment and are available also in advance on request.

Notes:

1. Where water from showers or hose-down cleaning comes in contact with partitions, Bobrick 1080 Series water-resistant, solid phenolic partitions are recommended.
2. Ceiling-hung partitions require structural members (not furnished by Bobrick) in ceiling. For suggested types of ceiling support systems, see Bobrick Advisory Bulletin TB-32.
3. Wall backing is required to secure the mounting brackets of panels, stiles, and wall posts. For suggested wall backing, see Bobrick Advisory Bulletin TB-46.
4. Floor-anchored stiles are furnished with expansion anchors and threaded rods. The expansion anchors require minimum 2" (50mm) penetration into minimum 3" (75mm) thick structural concrete.
5. Bobrick stainless steel partition-mounted washroom accessories are available for mounting in panels between two compartments. See current Bobrick Catalog for description of accessories. Cutouts in panels can be pre-cut for Bobrick models at factory if location and size of all cutouts and Bobrick model numbers are furnished at time of order.

GUARANTEE:

The Bobrick toilet partition panels, doors and stiles are warranted for a period of 2 years against breakage, corrosion, delaminating and defects in workmanship from the date of purchase for the periods set forth (this limited warranty is conditioned on the toilet partitions being properly installed, used and serviced). Spraying down or hosing HPL partitions voids warranty. Any products returned to Bobrick under this guarantee will be repaired or replaced at no charge.

SPECIFICATION:

High pressure laminate Toilet Partitions (insert one: toilet partitions or urinal screens) shall be over-head braced (insert one: floor-anchored, ceiling-hung, overhead-braced or wall-hung). Stiles, panels, and doors shall have a finished thickness of 1" (25mm). Core of panels, doors, and stiles* shall be 3-ply, 45-lb (20.4-kg) density, resin-impregnated particle board. Stiles shall have a one-piece, Type-304, satin-finish stainless steel shoe that is 4" (102mm) high. Surfaces and edges shall be .050" (1.3mm) thick, high pressure laminate with colored face sheets and matte finish; bonding shall be done using adhesives especially formulated to prevent delamination from moisture and heat normally existing in public washrooms. Stiles, panels, and doors shall be _____ (insert color name and number from current Bobrick Catalog). Headrails for overhead-braced compartments shall be anodized aluminum with satin finish. All door hardware and mounting brackets shall be chrome-plated zamak**. Theft-resistant, one-way screws shall be furnished for all door hardware. Plated-steel Phillips screws shall be furnished for all mounting brackets. A coat hook shall be furnished for each door.

Toilet Partitions _____ (insert one: Toilet Partitions, Dressing Compartments, Urinal Screens) shall be 1542 Series (insert series number) of Bobrick Washroom Equipment, Inc., Clifton Park, New York; Jackson, Tennessee; Los Angeles, California; Bobrick Washroom Equipment Company, Scarborough, Ontario; Bobrick Washroom Equipment Pty. Ltd., Australia; and Bobrick Washroom Equipment Limited, United Kingdom.



HIGH PRESSURE LAMINATE (HPL) STANDARD COLORS & PATTERNS

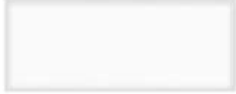

Designer White
D354-60



Natural Almond
D30-60



Beige
1530-60



Otter
3202-58



Shadow
D96-60



Slate Grey
D91-60

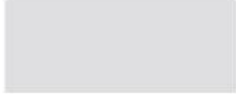

Moonstone
7872-58



Grey
1500-60



Platinum
D315-60



Mouse
928-58

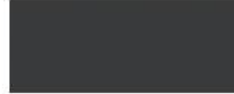

Terril
2297-58

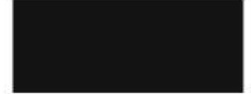

Black
1595-60



White Carrara
4924-38



Neutral Weft
5875-58



Flax Gauze
7708-58



Desert Zephyr
4841-60



Cardboard Solidz
7813-58



Pewter Mesh
4878-38



Sheer Mesh
4876-38



Classic Linen
4943-38



Satin Stainless
4830K-18*



Citadel Warp
5882-58



White Ash
8841-58



Field Elm
7999-60*



Danish Maple
8906-58



Millennium Oak
5887-58



Bleached Legno
8845-58



Smoky Brown Pear
5488-58



Blackened Steel
8918-58