

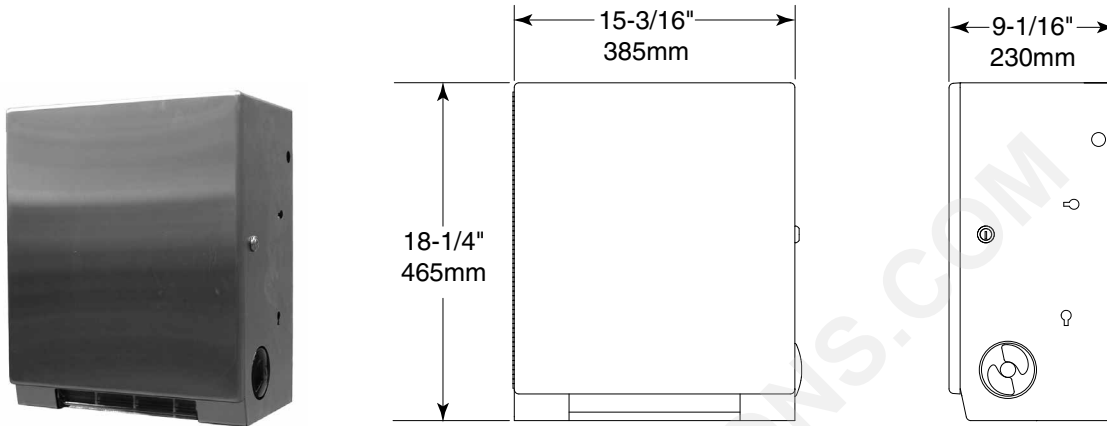

Technical Data

ClassicSeries® CONVERTIBLE UNIVERSAL ROLL TOWEL MODULE

3961-50



MATERIALS:

Touch-Free Pull Towel Mechanism — Durable, high-impact resin materials. Accepts universal standard-core non-perforated rolls 8" (205mm) wide, 8" (205mm) diameter, 800 ft (244mm) long. Dispenses one 12" (300mm) length of towel per pull. Accommodates up to 3-1/2" (90mm) diameter stub roll with automatic transfer to full roll.

Cabinet — 18-8, Type 304, heavy-gauge stainless steel. All-welded construction. Exposed surfaces have satin-finish. Equipped with a tumbler lock keyed like other Bobrick washroom accessories.

Door — 18-8, Type 304, 20-gauge (0.9mm) stainless steel with satin-finish. Drawn, one-piece, seamless construction. Secured to cabinet with a full-length stainless steel piano-hinge.

OPERATION:

Touch-Free roll towel dispensing mechanism dispenses one 12" (300mm) length of paper towel per pull and operates smoothly and quietly. User only touches the paper. Exterior paper towel feed wheel available for use when filling dispenser and for user to advance paper should it become necessary to feed paper through dispenser. Automatic transfer dispenses stub roll before new roll is dispensed. When stub roll is depleted, advancement of paper towel feed wheel allows the main roll to start dispensing without the need to open the dispenser. Dispenses universal, 1-1/2" to 2" (38 to 51mm) diameter core, up to 8" (205mm) wide, 8" (205mm) diameter, non perforated, non-proprietary paper towel rolls and dispenses with less than 5 pounds of force (22.2 N) to comply with accessible design (including ADAAG in U.S.A.).

To adapt to changing needs of washrooms, this unit is field convertible with the Folded Towel Dispenser or Automatic, Universal Roll Towel Dispenser. To order convertible modules, reference part numbers below under Options.

Options:

- Folded Towel Dispenser Module convertible in field: order Bobrick Part No. 3944-52.
- Automatic, Universal Roll Towel Dispenser Module convertible in field: order Bobrick Part No. 3974-50.

INSTALLATION:

Remove existing dispenser module, then install new convertible (Mechanical) universal roll towel module per form No. 3961-69. For removal of Convertible Folded Towel Dispenser Module refer to Form No. 3944-69. For removal of Automatic Universal Roll Paper Towel Module refer to Form No. 3974-69.

SPECIFICATION:

Convertible universal touch-free roll towel module shall be Type 304 stainless steel with all-welded construction; exposed surfaces shall have satin finish. Door shall be secured to cabinet with a full-length stainless steel piano-hinge and equipped with a tumbler lock keyed like other Bobrick washroom accessories. Towel mechanism dispenses universal, 1-1/2" to 2" (38 to 51mm) diameter core, up to 8" (205mm) wide, 8" (205mm) diameter, non perforated, non-proprietary paper towel rolls. 800 ft (244mm) long. Touch-Free pull towel mechanism dispenses one 12" (300mm) length of towel per pull. User only touches the paper. Automatic transfer shall dispense stub roll up to 3-1/2" (90mm) diameter before new roll is dispensed. Equipped with paper towel feed wheel for use in filling the dispenser, or for user to advance paper should it become necessary to feed paper through dispenser. Paper towels are dispensed with pull force of less than 5 pounds (22.2 N) to comply with accessible design (including ADAAG in U.S.A.).

Convertible Universal Touch-Free Roll Towel Module shall be Model 3961-50 of Bobrick Washroom Equipment, Inc., Clifton Park, New York; Jackson, Tennessee; Los Angeles, California; Bobrick Washroom Equipment Company, Scarborough, Ontario; Bobrick Washroom Equipment Pty. Ltd., Australia; and Bobrick Washroom Limited, United Kingdom.