



Security framed wall mirror:

Model SA05 – Front Mounted

Product Materials

INTEGRAL FRAMED MIRROR: 20 gauge stainless steel, polished to a #8 architectural bright finish. Stretcher leveled for uniformity. Very bright – excellent reflectivity, very slight polish grain.

Stainless steel mirrors will differ in optic quality from glass mirrors.

Installation

Verify all rough-in dimensions prior to installation. Unit supplied with ¼" - 20 x 1½" T27 torx head machine screws for installation to wall anchors (not included).

Guide Specification

Security mirror with integral frame shall be fabricated of 20 gauge stainless steel, with #8 architectural finish die formed from a single sheet. Frame has countersunk holes for mounting and is furnished with ¼"-20 x 1½" long torx-head machine screws. for installation to wall anchors (not included).

Overall dimensions: 11¼"W x 17¼"H x ¼"D.

ADA Compliant

- Consult local and national accessibility codes for proper installation guidelines.
- Conformity and compliance to local and national codes is the responsibility of the installer.

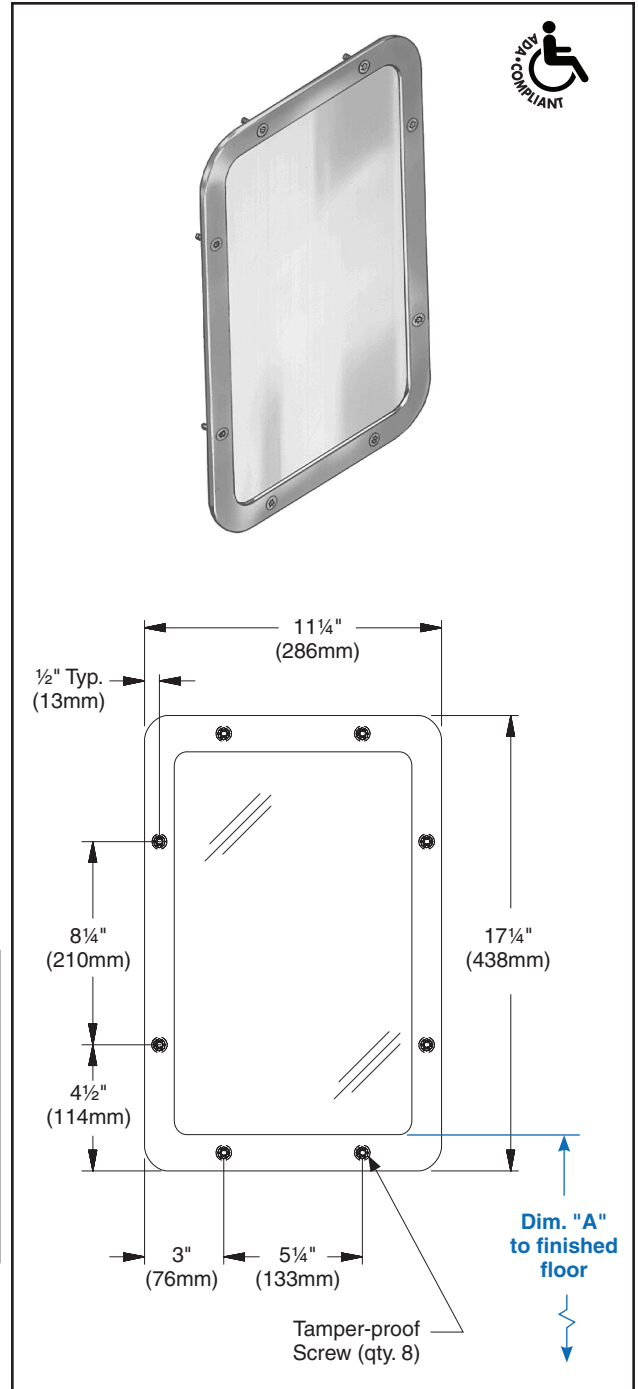

Dim. "A" Key Surface:	For Dim. "A"	Top of Unit	Bottom of Unit
Mirror's bottom edge of the reflective surface to finished floor	40" (1016mm)	56¼" (1429mm)	39" (991mm)
	37" (940mm)	53¼" (1353mm)	36" (914mm)
	34" (864mm)	50¼" (1276mm)	33" (838mm)
Rough wall opening:			
Surface Mount:	No rough wall opening, see overall dimensions		