



- Model 2027 — Recessed **Bradex**[®]
- Model 2027-10 — Semi-Recessed (recesses 2 1/8"; projects 2")
- Model 2027-11 — Surface-Mounted (projects 4 1/8")
- Contemporary Series — Satin Finish

Product Materials

CABINET: 22 gauge stainless steel with exposed surfaces in architectural satin finish. Welded construction with seamless corners and burr-free edges.

DOOR: 18 gauge stainless steel. 1/2" return for maximum rigidity. Concealed full-length stainless steel piano hinge and two tumbler locks keyed like other Bradley units.

TOWEL DISPENSER: 22 gauge stainless steel. Rolled edge on dispenser opening.

WASTE RECEPTACLE INSERT: leakproof molded plastic.

Capacity

Towel Dispenser — 800 multi-fold or 600 C-fold paper towels. Waste Receptacle Insert — 3.7 gal. (0.5 cu. ft.)

Operation

Towel dispenser holds multi-fold or C-fold towels without use of special adaptor. Waste receptacle insert removable by unlocking cabinet door.

Installation

Verify all rough-in dimensions prior to installation. Recessed unit requires rough wall opening 11 3/4"W x 53 3/8"H x 3 3/4"D (Semi-recessed unit only 2 1/2" deep). Secure to framing with mounting screws (included) at holes provided. Shim at screw points as required. Surface-mounted units must have holes drilled by installer.

Guide Specification

Recessed combination towel dispenser and waste receptacle shall be fabricated of heavy gauge stainless steel with exposed surfaces in satin finish. Cabinet door of 18 gauge stainless steel with full length piano hinge and secured by 2 tumbler locks. Towel dispenser capacity 800 multi-fold or 600 C-fold towels. Removable 3.3 gal. leakproof molded plastic insert for waste receptacle.

Overall dimensions: 13"W x 55"H x 4 1/8"D.



ADA Compliant

- Consult local and national accessibility codes for proper installation guidelines.
- Conformity and compliance to local and national codes is the responsibility of the installer.

Orders composed of products indicated as **Bradex**[®] will be available to ship in three days after receipt of order at the factory. There is no pricing penalty for this service from Bradley.



Dimensions

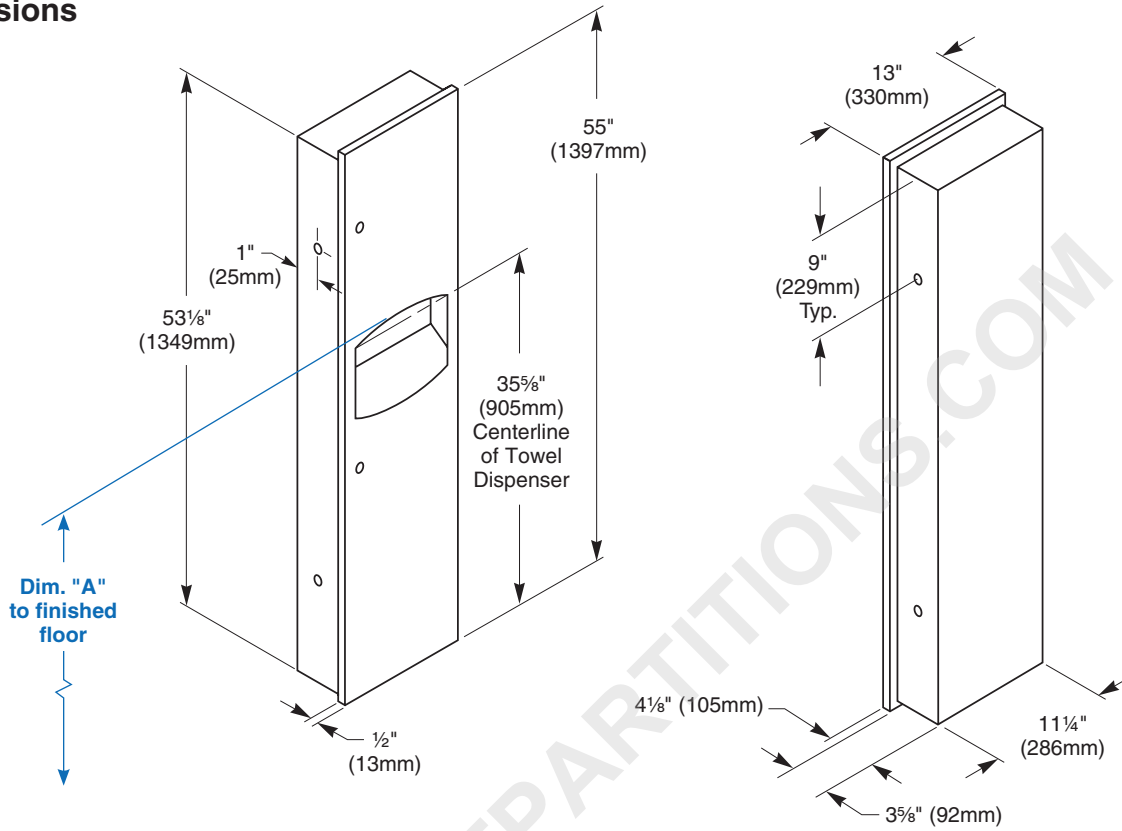

Dim. "A" Key Surface:	For Dim. "A"	Top of Rough Wall Opening	Bottom of Rough Wall Opening
Paper towel top of opening to finished floor	48" (1219mm)	66 1/4" (1683mm)	12 5/8" (321mm)
	45" (1143mm)	63 1/4" (1607mm)	9 5/8" (244mm)
	42" (1067mm)	60 1/4" (1530mm)	6 5/8" (168mm)
	40" (1016mm)	58 1/4" (1480mm)	4 5/8" (117mm)
Rough wall opening:			
Surface Mount:	No rough opening, see overall dimensions		
Recessed:	11 3/4" (299mm) Wide x 53 5/8" (1363mm) High x 3 3/4" (96mm) Deep		
Semi-recessed:	11 3/4" (299mm) Wide x 53 5/8" (1363mm) High x 2 1/2" (64mm) Deep		

Orders composed of products indicated as **Bradex**® will be available to ship in three days after receipt of order at the factory. There is no pricing penalty for this service from Bradley.